

UP. EXTREMITY

SURGICAL  
TECHNIQUE

# TELEGRAPH

EVOLUTION<sup>®</sup>

Cannulated humeral nail

GROUP  
**FH ORTHO**<sup>™</sup>

# 1. FEATURES

## Nails

- Short and long, right and left lateralized.
- Straight.
- 2,5 mm cannulated for 2,4 mm wire.
- Ti6Al4V (grey titanium alloy).
- Proximal diameter:
  - $\varnothing 9$  for the 7, 8 and 9 mm nail,
  - $\varnothing 10$  for the 10 mm nail.
- Short nail: single length 150 mm
- Long nail: lengths 210, 230, 250, 270 and 290 mm.

## Proximal self-tapping screws

- $\varnothing 4$  mm (2,3 mm screw core - 2,5 mm drill bit).
- Lengths: 25, 30, 40, 45, 50 and 55 mm.

## Washer for proximal screw

- 4 mm internal diameter.
- 11 mm external diameter.
- Perforation.

## Orientation of screws for proximal fixation

### Screw 1:

Transverse to secure the greater tubercle and the humeral head.

### Screw 2:

Oblique, from front to back, from outside to inside, to secure the greater tubercle and the head.

### Screw 3 (optional):

Anteroposterior, to secure the lesser tubercle and the head.

### Screw 4:

From outside to inside, back to front: to secure the greater tubercle and the humeral head.

## Distal self-tapping screws

- $\varnothing 4$  mm (2,9 mm screw core - 3,1 mm drill bit)
- Lengths: 20, 24, 28, and 32 mm.
- Screw orientation:
  - Short nail: lateromedial,
  - Long nail: anteroposterior.

## SHORT NAIL L150

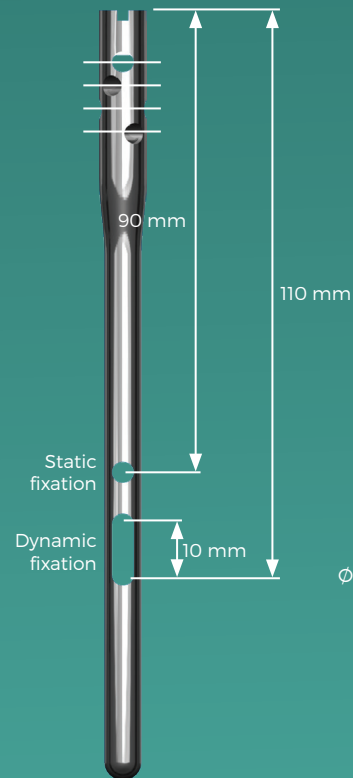

## LONG NAIL L210, 230, 250, 270, 290

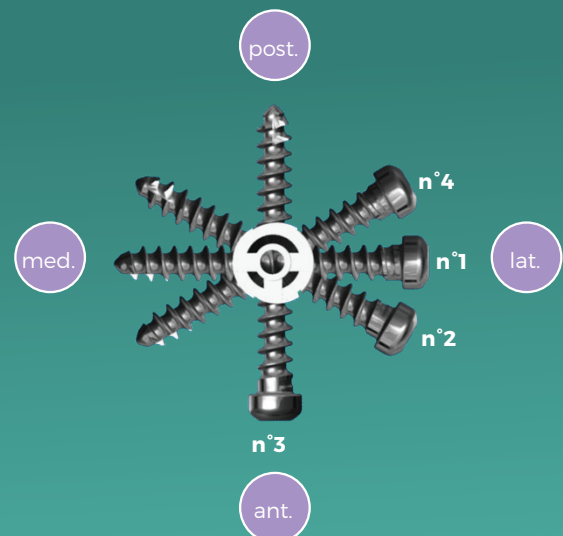
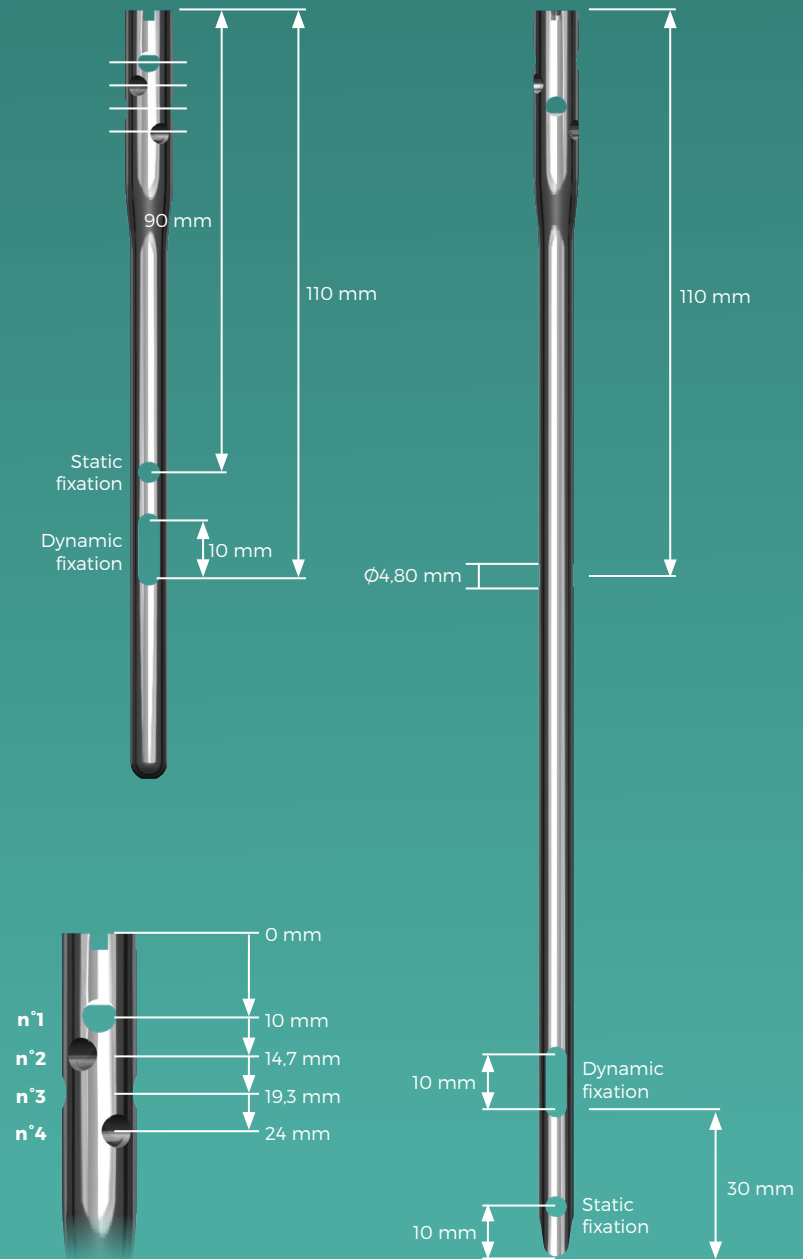

## 1.1. Indications

The TELEGRAPH® nail was developed to treat fractures of the proximal humerus and/or humeral diaphysis. The TELEGRAPH EVOLUTION® cannulated nail, used in these same indications, is a reliable and accurate means of internal fixation that is simple to implement.

## 1.2. Implants references



TELEGRAPH EVOLUTION®			
Short cannulated humeral nail - left			
Ref.	Length	Ø prox.	Ø dist.
270 741	L150	9	7
270 742	L150	9	8
270 743	L150	9	9
270 744	L150	10	10



TELEGRAPH EVOLUTION®			
Short cannulated humeral nail - right			
Ref.	Length	Ø prox.	Ø dist.
270 745	150	9	7
270 746	150	9	8
270 747	150	9	9
270 748	150	10	10



TELEGRAPH EVOLUTION®	
Proximal screw <span style="color: blue;">●</span>	
Ref.	Designation
270 789	Ø4 L25
270 790	Ø4 L30
270 791	Ø4 L35
270 792	Ø4 L40
270 793	Ø4 L45
270 794	Ø4 L50
270 795	Ø4 L55



TELEGRAPH EVOLUTION®			
Long cannulated humeral nail - left			
Ref.	Length	Ø prox.	Ø dist.
270 749	L210	9	7
270 750	L230	9	7
270 751	L250	9	7
270 752	L270	9	7
270 753	L290	9	7
270 754	L210	9	8
270 755	L230	9	8
270 756	L250	9	8
270 757	L270	9	8
270 758	L290	9	8
270 759	L210	9	9
270 760	L230	9	9
270 761	L250	9	9
270 762	L270	9	9
270 763	L290	9	9
270 764	L210	10	10
270 765	L230	10	10
270 766	L250	10	10
270 767	L270	10	10
270 768	L290	10	10



TELEGRAPH EVOLUTION®			
Long cannulated humeral nail - right			
Ref.	Length	Ø prox.	Ø dist.
270 769	210	9	7
270 770	230	9	7
270 771	250	9	7
270 772	270	9	7
270 773	290	9	7
270 774	210	9	8
270 775	230	9	8
270 776	250	9	8
270 777	270	9	8
270 778	290	9	8
270 779	210	9	9
270 780	230	9	9
270 781	250	9	9
270 782	270	9	9
270 783	290	9	9
270 784	210	10	10
270 785	230	10	10
270 786	250	10	10
270 787	270	10	10
270 788	290	10	10



TELEGRAPH EVOLUTION®	
Distal screw <span style="color: yellow;">●</span>	
Ref.	Designation
270 796	Ø4 L20
270 797	Ø4 L24
270 798	Ø4 L28
270 799	Ø4 L32



TELEGRAPH EVOLUTION®	
Washer Internal diameter 4 External diameter 11	
Ref.	Designation
270 800	Washer

OPTIONAL

## 2. GENERAL RULES AND TECHNIQUES

### 2.1. Patient positioning

- The patient is in a beach chair position.
- The forearm rests on an armrest.
- The arm is in retraction of 25 - 30° in relation to the chest to expose the point of entry.
- The C-arm is placed longitudinally at the patient's head (fig. 1).

Before the beginning the procedure, check that the humerus is clearly visible with the image intensifier.

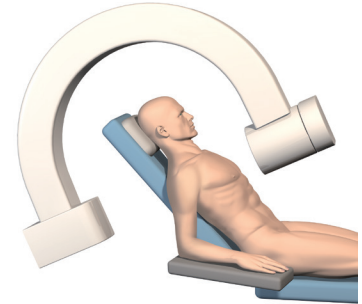



fig. 1

### 2.2. Approach and entry point

Different approaches are possible depending on the type of fracture and the reduction technique (see section 6).

- Visually and/or with radiographic guidance locate the entry point which is at the humeral head apex (fig. 2).
- Open the rotator cuffs through the muscle area (rather than tendons) at the supraspinatus, either using an open or percutaneous technique.

 **Option:** to avoid incision of the rotator cuffs, you can also go through the rotator interval.

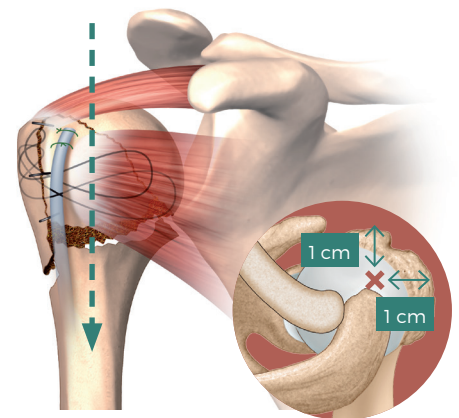



fig. 2

Use the cannulated square awl (ref. 270 806) to bore the humeral head around 1 cm behind the bicipital groove (under radiographic guidance), +/- protection sleeve (ref. 270 807) (fig. 3a).

 **Option:** to make the entry point at the humeral apex, a pin and 9 mm diameter cannulated drill bit can be used.

- Insert the nail guide (non-sterile pin ref. 271 326) into the orifice of the cannulated square awl then advance into the medullary cavity once the fracture has been reduced (fig. 3b).

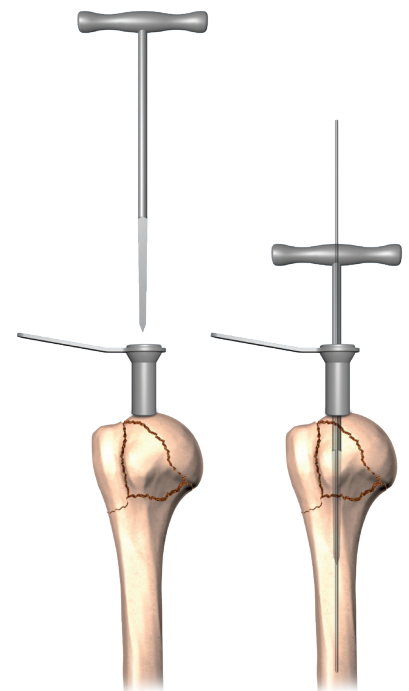

fig. 3a

fig. 3b

- Gradually prepare the medullary cavity with rigid hand reamers with a diameter of 7, 8 or 9 mm (10 mm optional) (**ref. 270 808, 270 809, 270 810, 270 811**), depending on the final diameter of the chosen intramedullary nail (**fig. 4a**).
- The proximal humerus must be reamed to 9 mm diameter for 25 mm to fit the nail (**fig. 4b**).

**Remember that all the nails in the TELEGRAPH EVOLUTION® range have a proximal diameter of 9 mm, except for the 10 mm nails, which are an optional extra (10 mm proximally and distally).**

### Measurement of the long nail

The measurement is read directly on the hand reamers. If the protection sleeve (**ref. 270 807**) is still in place, its height of 40 mm must be subtracted from the result.

### 💡 Tips and tricks for fracture reduction:

The 7 mm diameter rigid reamer can be used to help reduce the fracture and to guide the insertion of the nail guide (non-sterile pin **ref. 271 326**) in complex diaphyseal fractures.

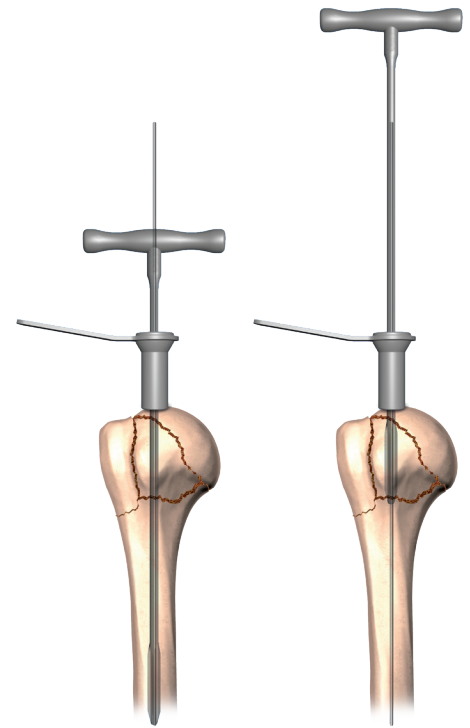

fig. 4a

fig. 4b

## 2.3. Nail fitting and positioning



### NB:

When mounting the nail on the nail holder (**ref. 264 201**) with the cannulated connecting screw (**ref. 270 812**) make sure that the nail is pointing in the correct direction ("MED" and "LAT" are engraved on it).

- Check that the sleeves and drill bits are correctly aimed in the nail locking holes.
- The nail is advanced on the nail guide (non-sterile pin **ref. 271 326**) to 5 mm below the joint surface.
- The nail holder has a laser mark (notch) (**fig. 5**) for easy radiographic identification.
- Remove the nail guide (non-sterile pin **ref. 271 326**).

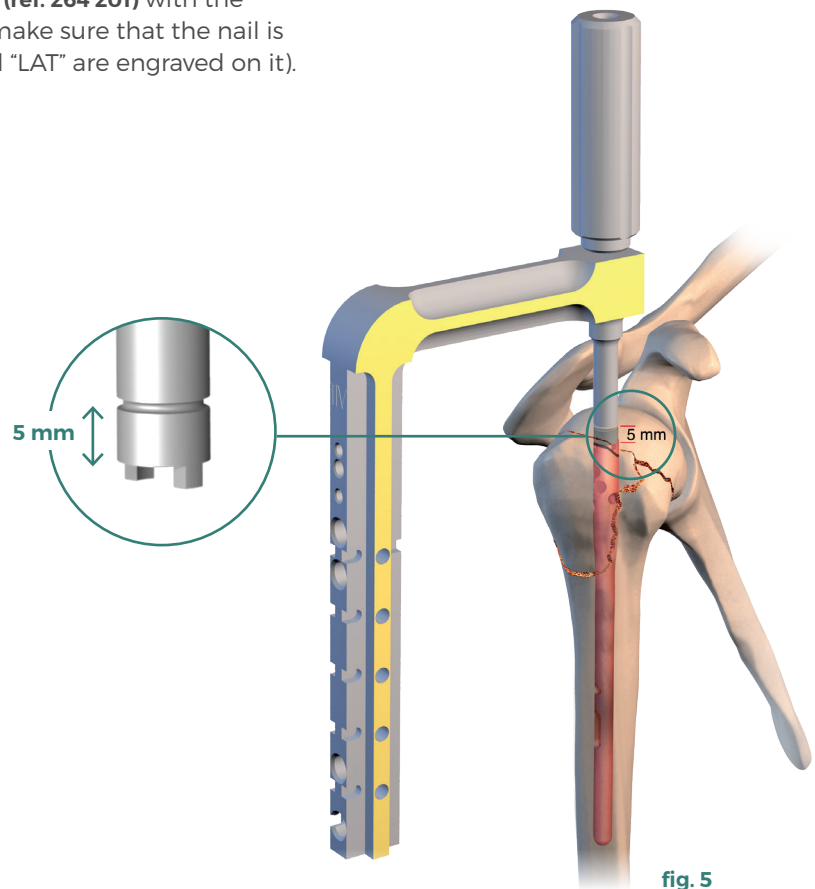
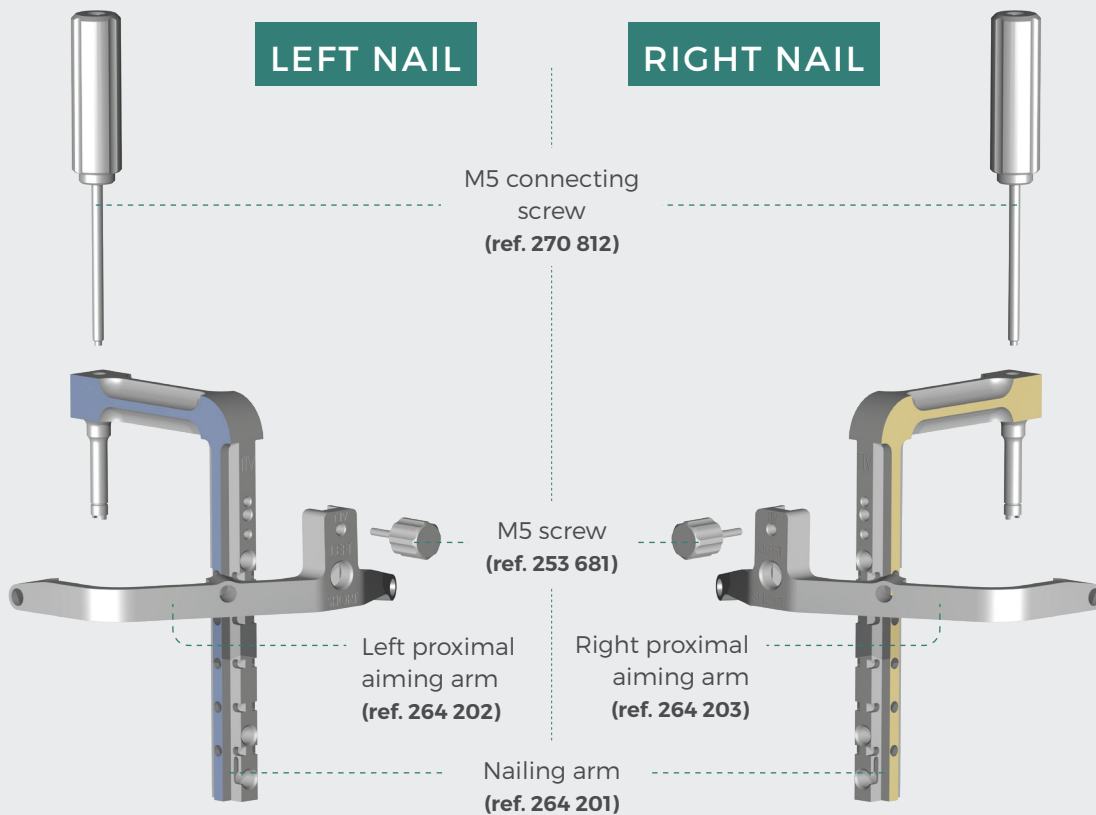

fig. 5

## 2.4. Proximal locking for both short and long nails

Assemble the insertion handle (ref. 264 201) and the left (ref. 264 202) or right proximal guide (ref. 264 203) with the M5 screw (ref. 270 812) (fig.6).



### Recommendation:

If the screw resists the passage of the self-stability in the nail in the presence of particularly dense bone, **DO NOT FORCE**, remove the screw and proceed to **TAPPING** the first cortex.

6

**Step n°1:** Using the aiming sleeves (drill sleeve ref. 253 677 and drill guide sleeve ref. 253 678), perform the preparatory drilling ( $\varnothing 2.5$  mm drill bit ref. 250 855) for the first screw 1.

**Leave the drill bit in place to stabilise the fixation.**

**Step n°2:** Preparatory drilling for the second screw (optional), the length can be read directly on the drill bit. Remove the drill guide then fit the screw using the screwdriver (ref. 233 339).

**Step n°3:** Continue with drilling and fitting the subsequent screws then finish with screw 1.

### 2,5 mm proximal drilling:

- 2.5 mm sleeve
- 2,5 mm drill bit

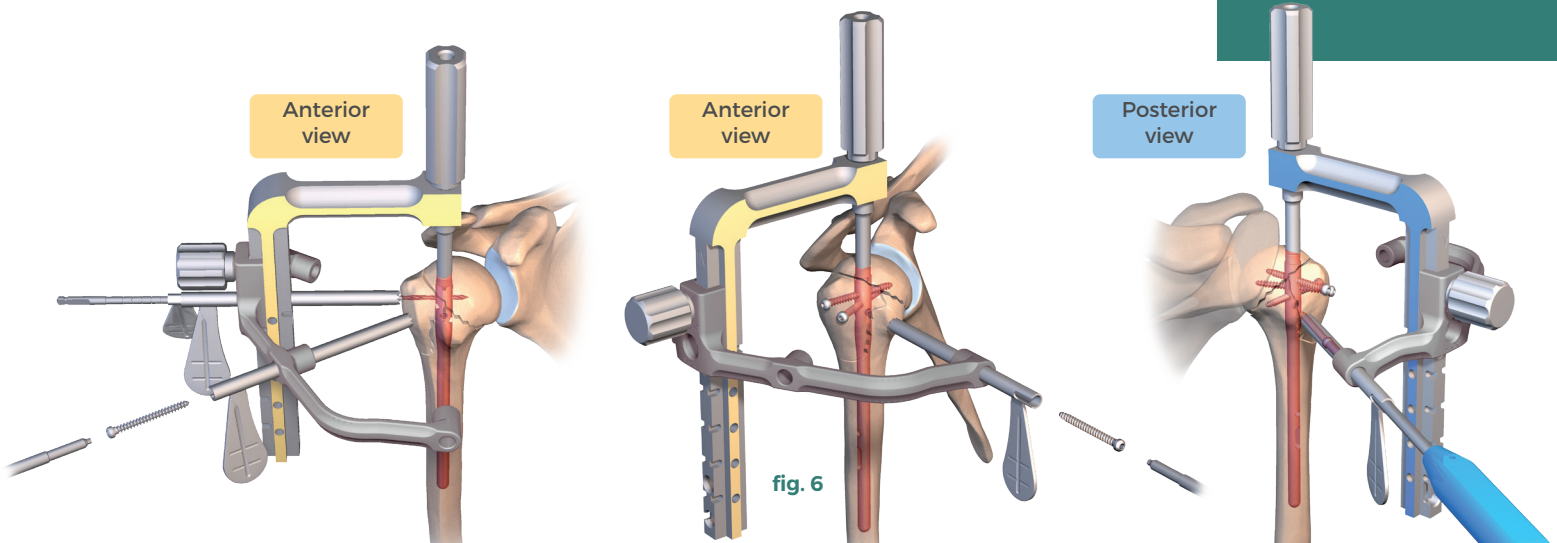

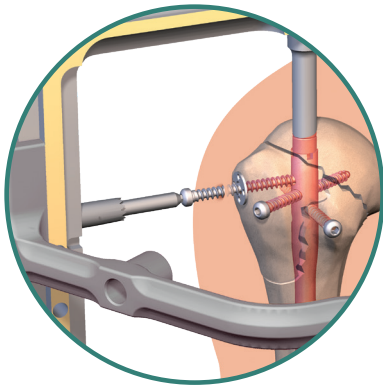

fig. 7



**Option:** A washer (**ref. 270 180**) can be used on each proximal screw in order to optimise compression of the bone fragment and/or to allow osteosuturing. The washer is fitted once the aiming sleeve has been partially removed by about 1 cm from the skin (**fig.7**).

## 3. DISTAL LOCKING

### 3.1. Short nail



**NB:**

- Dynamic nailing is recommended for stable fractures (choose the most distal hole on the nailing arm).
- For complex or unstable fractures, use static nail locking.

- Insert the blunt tip drill guide sleeve D3.1 mm (**ref. 270 822**) into the aiming sleeve (**ref. 253 678**), until contact is made with the diaphyseal cortical bone (**fig.8**).

- Drill with the D3.1 mm bit (**ref. 270 821**) (**fig.9**) and read the screw length directly on the drill bit.

#### 3,1 mm distal drilling:

- 3,1 mm sleeve
- 3,1 mm drill bit

- Remove the blunt tip drill guide sleeve (**ref. 270 822**) and fit the distal screw using the 2.5 screwdriver (**ref. 233 339**) (**fig.10**).

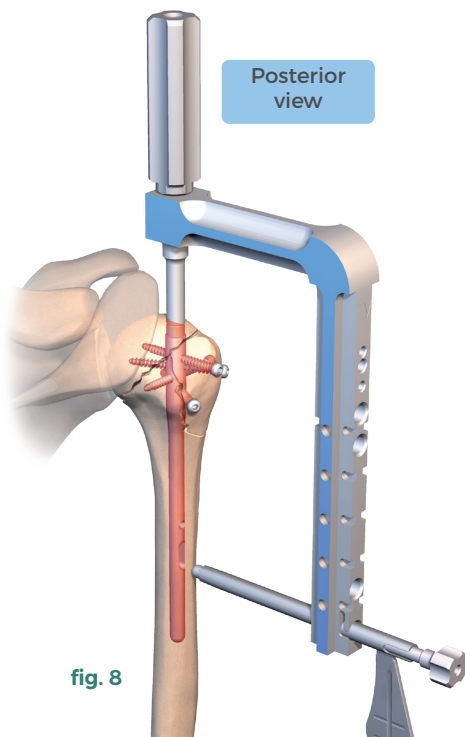

fig. 8

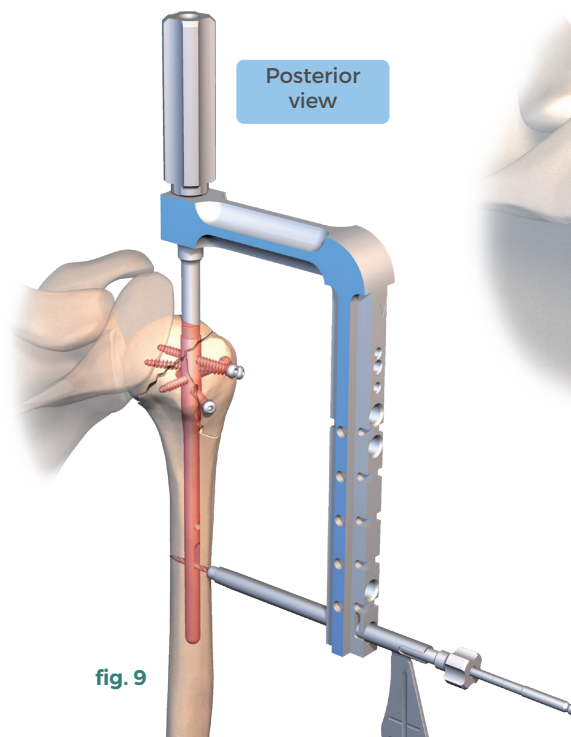

fig. 9

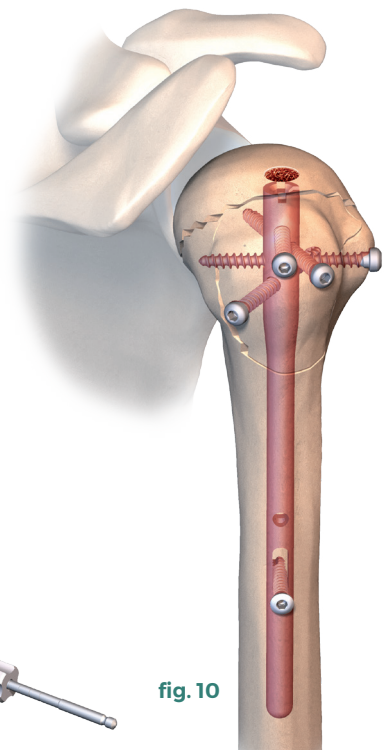

fig. 10

## 3.2. Long nail

### Fitting the intermediary positioner



**NB:**

This step is **indispensable** to anchor the nail holder for distal aiming and successful distal drilling.

· Insert the blunt tip eyelet handle (**intermediary obturator ref. 253 676**) into the aiming sleeve (**blue with notch ref. 257 010 or ref. 253 679**) until contact is made with the humerus (**fig.11**).

· Drill the outer cortex with the grey drill bit with stop (**ref. 266 428**) (**fig.12**).

· Insert the intermediate positioner (**ref. 253 675**) into the barrel (**fig. 13**), then rotate to allow the pin to be inserted into the hoop (**fig. 13a, 13b and 13c**) ensuring that the positioner is locked.

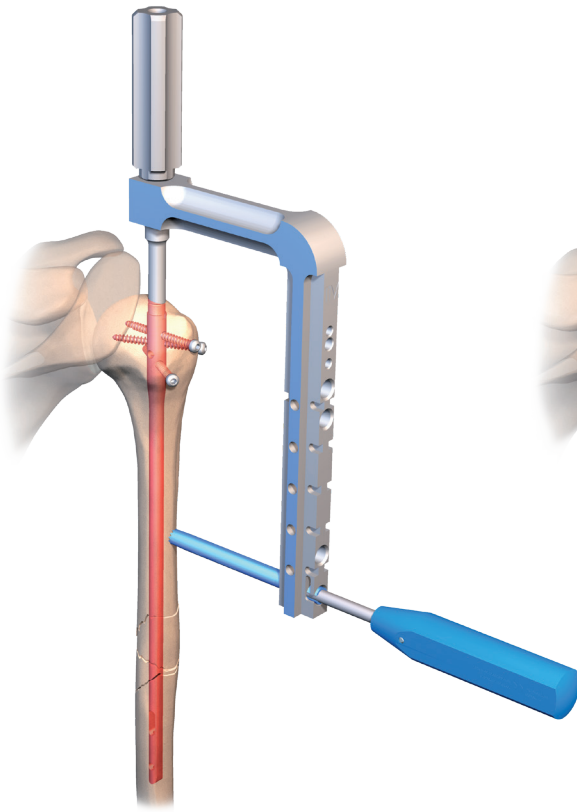

fig. 11

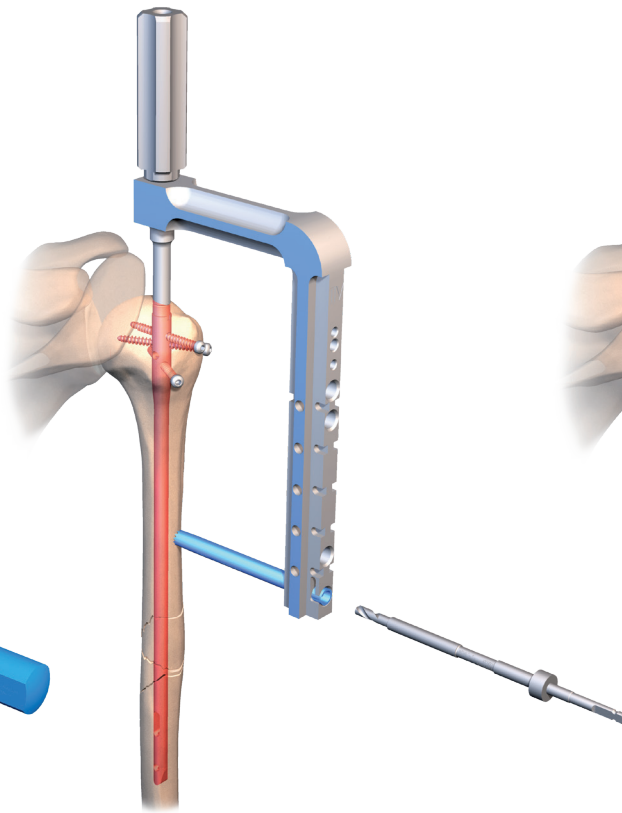

fig. 12

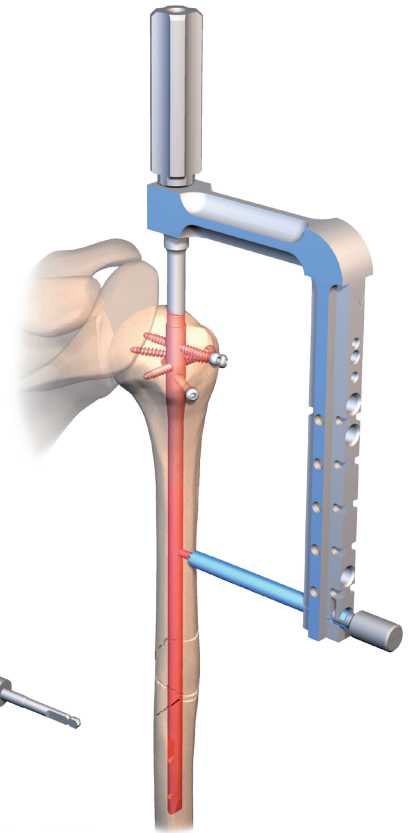

fig. 13

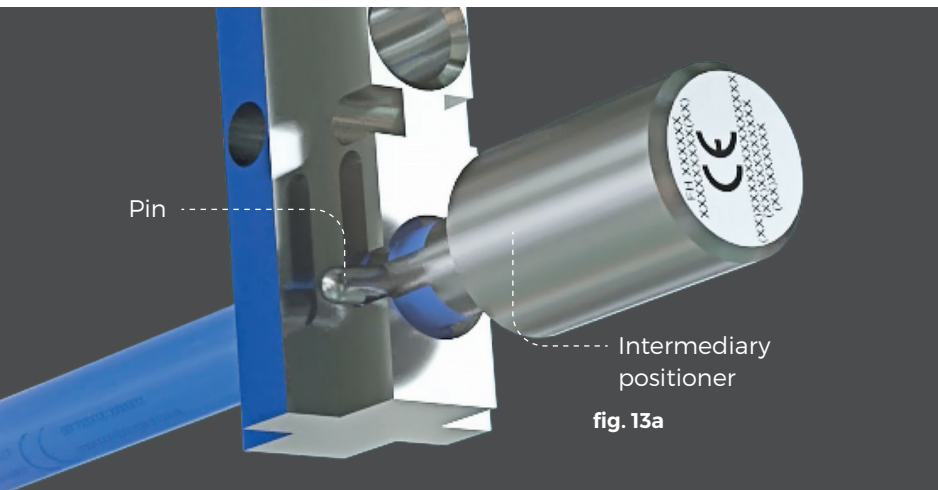

fig. 13a

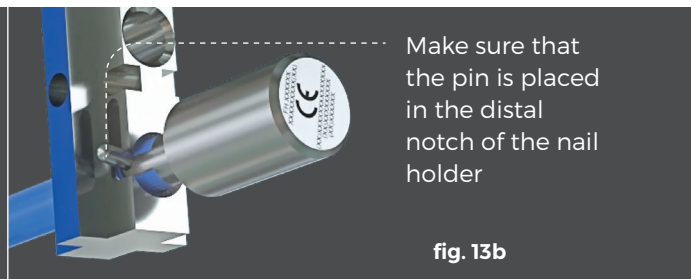

fig. 13b

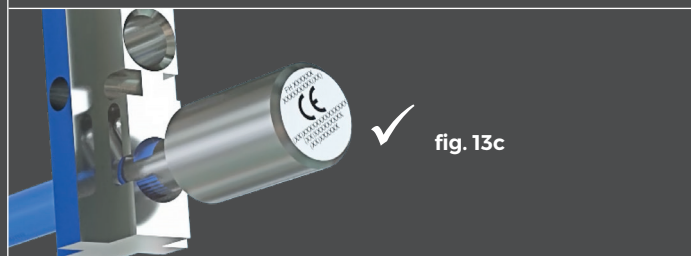
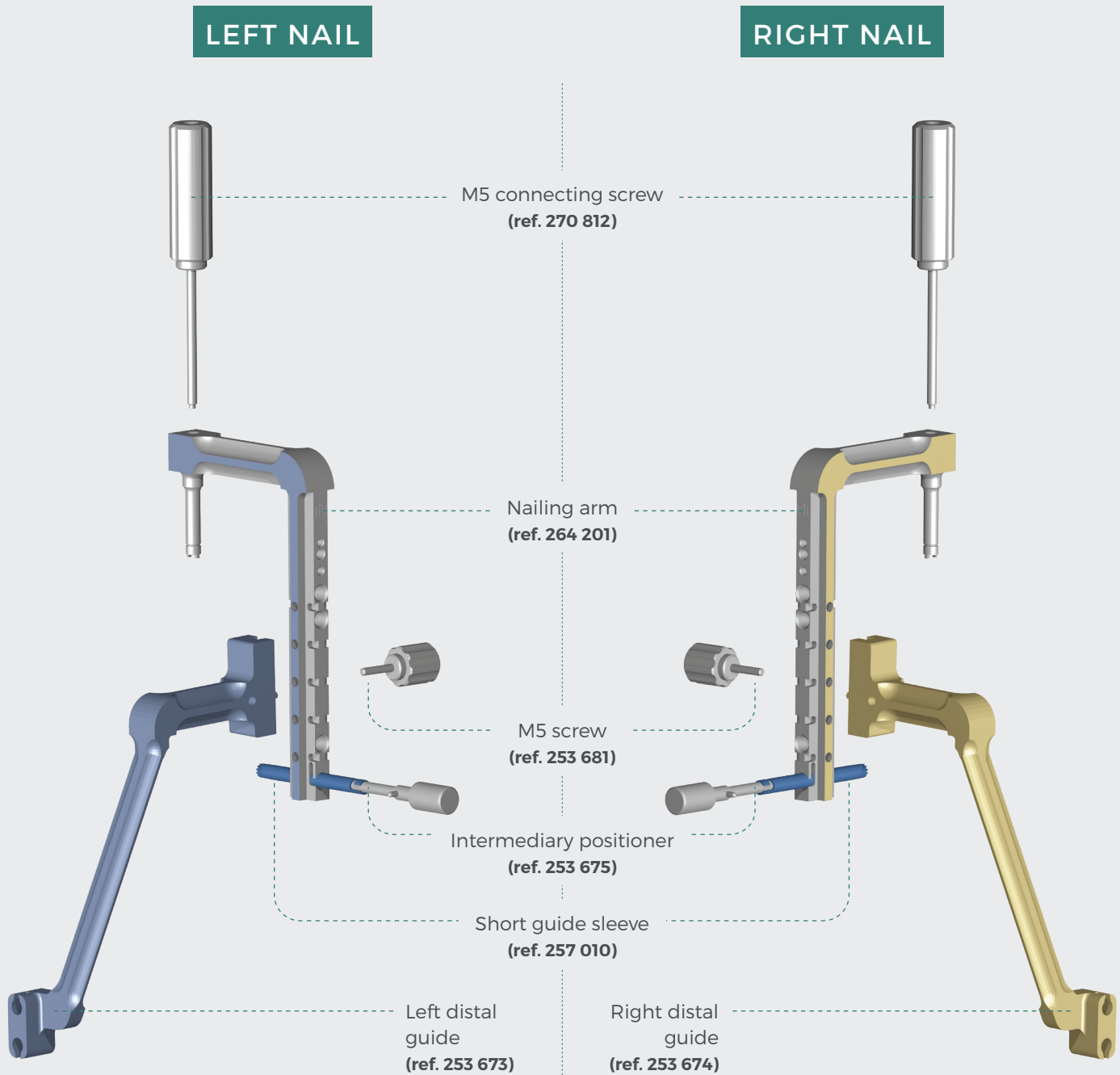

fig. 13c

## Distal locking

Assemble the insertion handle (ref. 264 201) and the blue left (ref. 253 673) or yellow right distal guide (ref. 253 674) with the M5 screw (ref. 270 812).



**NB:**

Dynamic nailing is preferred except in unstable fractures (most proximal hole of the distal guide).

· Insert the D3.1 mm blunt tip drill guide sleeve (ref. 270 822) into the aiming sleeve (ref. 253 678), until contact is made with the diaphyseal cortical bone and checking for an absence of stress on the soft tissue from the sleeve (fig.14).

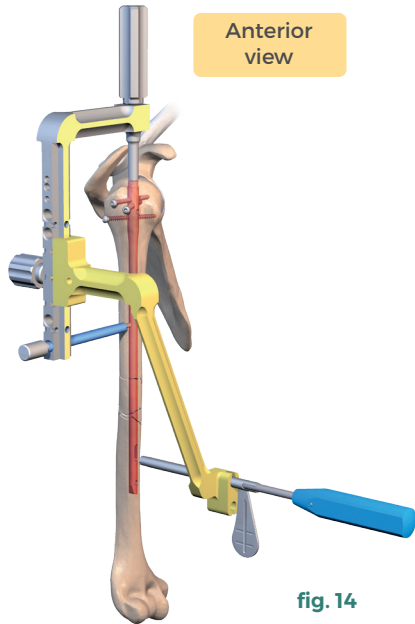

**NB:** Before drilling, check that alignment is correct and the aiming sleeve is centred on the nail using radiographic guidance (oblique view) (fig.15).

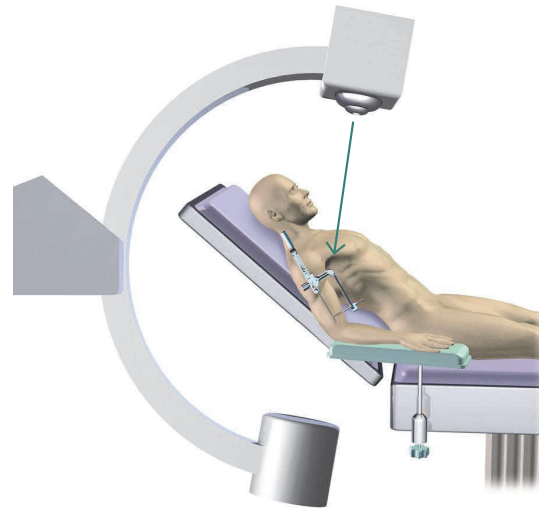

· Bicortical drilling with the D3.1 mm bit (ref. 270 821) (fig.16) and read the screw length directly on the drill bit.

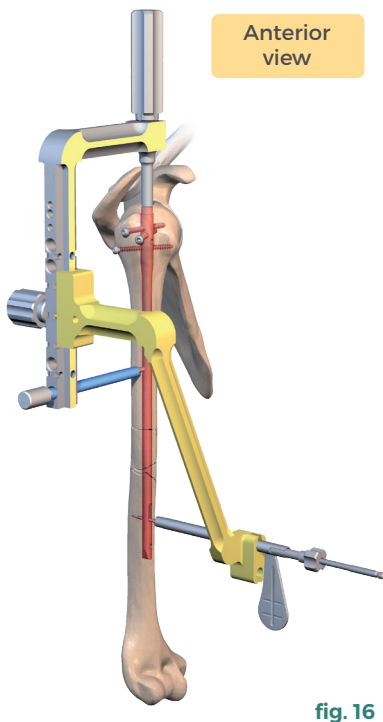

· Remove the blunt tip drill guide sleeve (ref. 270 822) and fit the distal screw using the 2.5 mm screwdriver (ref. 233 339) (fig.17).

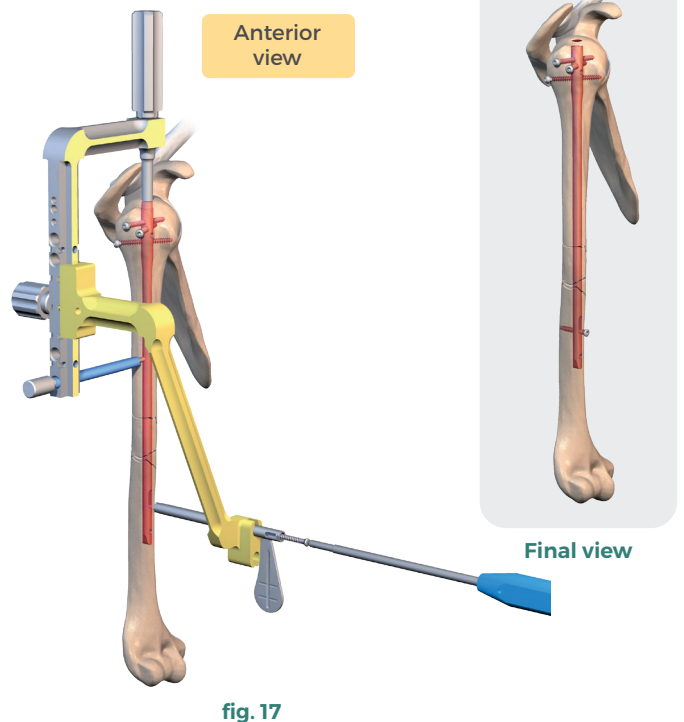

· Remove the instrumentation and suture the muscle incision at the rotator cuffs.

## 4. POSTOPERATIVE CARE

---

- The type and duration of immobilisation, ranging from 2 to 6 weeks, must be appropriate for the type of fracture and the stability of the fixation.
- Rehabilitation should also be chosen according to fracture type.
- Immediate post-operative rehabilitation should be preferred where possible with weight-bearing, even if this is passive.

## 5. REMOVING THE HARDWARE

---

Removal of TELEGRAPH EVOLUTION® is not routinely recommended. This procedure must be discussed in terms of the risk-benefit balance for every patient.

However, removal may be necessary in two situations:

- **The screws and/or nail protrude, causing discomfort.**
- **Young patient.**

For removal, refer to the dedicated surgical technique  
**Removal of the Telegraph nail.**



# 6. DIFFERENT REDUCTION TECHNIQUES BY FRACTURE TYPES

## 6.1. Percutaneous technique

### Extra-articular fracture with two or three fragments

Prior reduction is essential, either by external manipulation or percutaneously using a plate or pin - the joystick technique (fig. 18).

A short pre-acromial incision enables insertion of the blunt tip of the scissors as far as the humeral head.

The entry point at the top of the humeral head is marked using the square awl under radiographic guidance. This bores the humeral head.

The soft tissue retractor (ref. 236 844) enables access to the epiphysis for percutaneous fitting of the screws.

The next stages are those set out in paragraph 2.

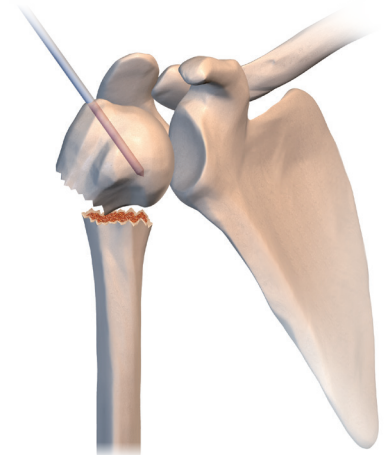

fig. 18

## 6.2. Standard technique

### Fractures with 3 fragments that cannot be reduced percutaneously and articular fractures with 4 fragments

The anterolateral approach involves the incision and creation of the digastric trapezius-deltoid muscle flap (fig. 19 and 20).

The incision measures 8 - 10 cm. It is centred on the anterolateral angle of the acromion, 1/3 proximal, 2/3 distal, following the direction of the fibres of the deltoid.

The trapezius-deltoid digastric flap is created by dissection between the middle and anterior deltoid fibres with periosteal stripping of the acromion in the same direction. The digastric muscle is reflected forwards, along with the coracoacromial ligament. The various fragments and in particular the tuberosities can be approached directly.

Reduction of bone fragments is achieved using a plate, a hook or external manipulation.

The head is generally tipped backwards. The fracture must be reduced.

If reduction is difficult, the "crucifixion" technique can be used (fig. 21). This involves pinning the humeral head in the anatomical position and against the glenoid with a K-wire.

After reduction, the nail is fitted as usual (paragraph 2).

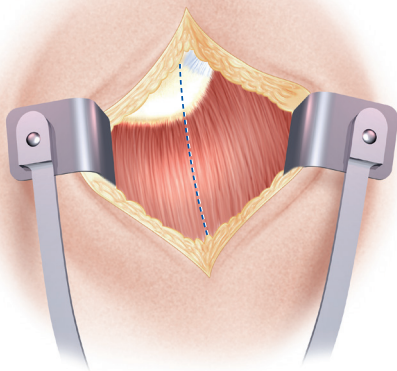

fig. 19

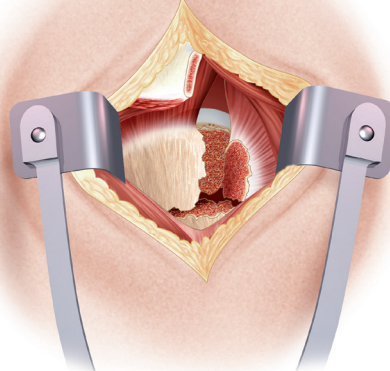

fig. 20

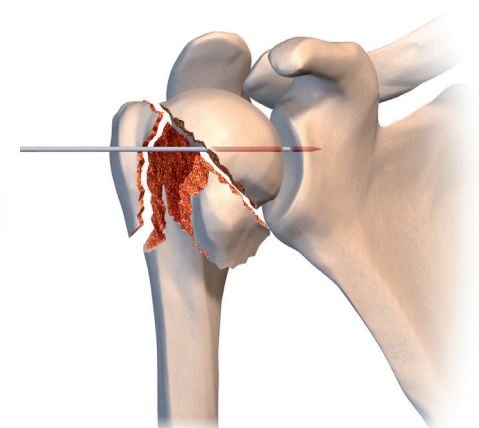
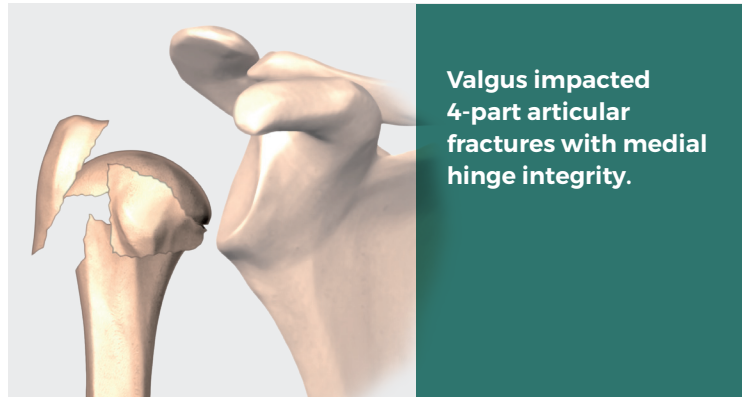
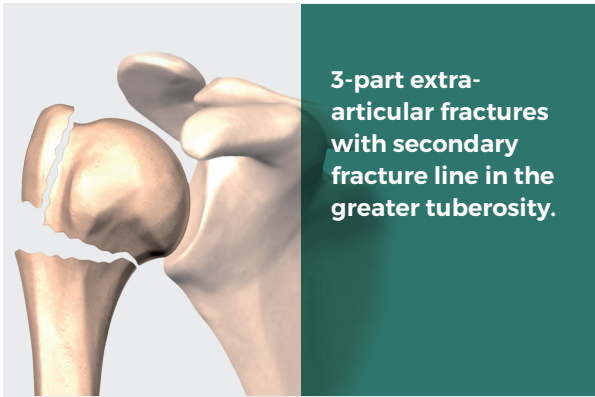

fig. 21

## 6.3. Treatment of 3- & 4-part fractures by osteosuture

### Indication



### Reduction and osteosuture

Reduce the humeral head via the inter-tuberosity fracture using a bone impactor applied to the superior edge of the humeral head, generally displaced into a valgus, posterior tilt position.

This manoeuvre is performed under radiographic guidance (fig. 22). Once the criteria for tuberosity reduction have been identified, this is performed and held by forceps (fig. 23).

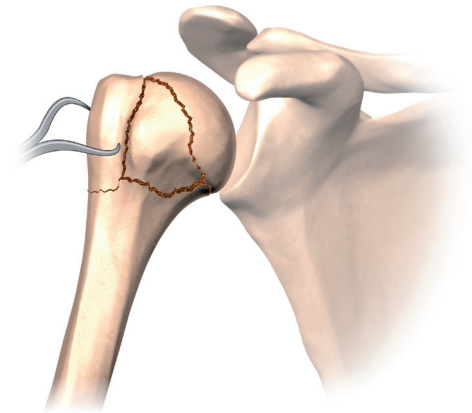
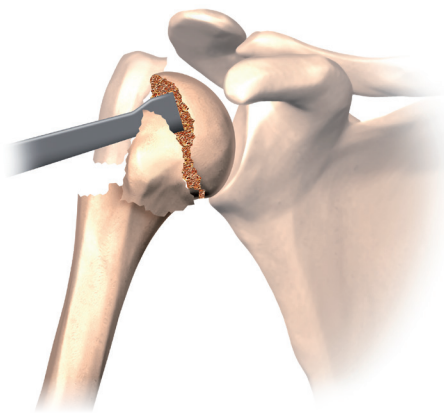

## TWO OPTIONS

### 1 Osteosuture without biceps tenotomy

Three transosseous wires are passed through the greater tubercle and lesser tubercle before reduction on both sides of the tuberosity fracture. The tuberosities are then reduced, held by forceps and the wiring is knotted. In this case, the bicipital groove is left free (fig. 24).

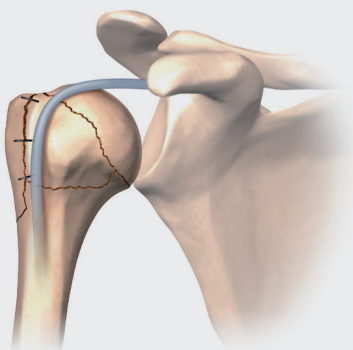

### 2 Osteosuture with biceps tenotomy & tenodesis

Suturing of the greater and lesser tuberosities is carried out by transtendon stitching at the «bone-tendon» junction. The bicipital groove is bridged, thus achieving tenodesis of the long head of the biceps. A tenotomy is necessary via a limited exposure incision through the rotator interval (fig. 25 and 26).

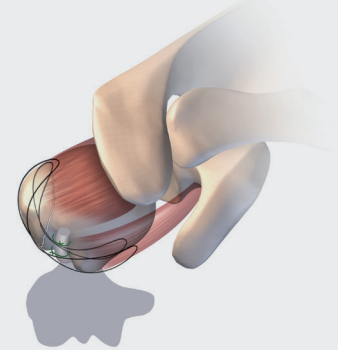
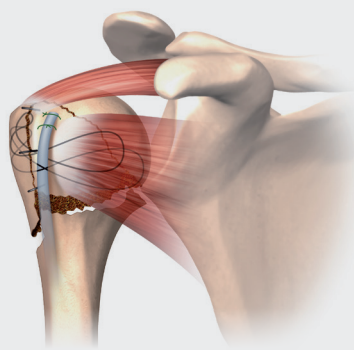

## 6.4. The Bilboquet

---

### Complex articular fractures

**Difficult surgery.** Only to be performed after having gained experience with the equipment. The conventional patient positioning and anterolateral approach are used (**paragraph 2**).

The nail is fitted, along with its nail holder, without fragment reduction. It is locked distally (**fig. 27**) by a static screw. The nail holder is removed.

The next stage consists of reducing the humeral head directly on the proximal part of the nail. It is screwed (**fig. 28**) to the nail using two screws. The tuberosities, marked on the wires, are reduced and sutured to the humeral head, the nail and the proximal diaphysis (**fig.29**). They can also be stabilised with screws no. 3 and 4.

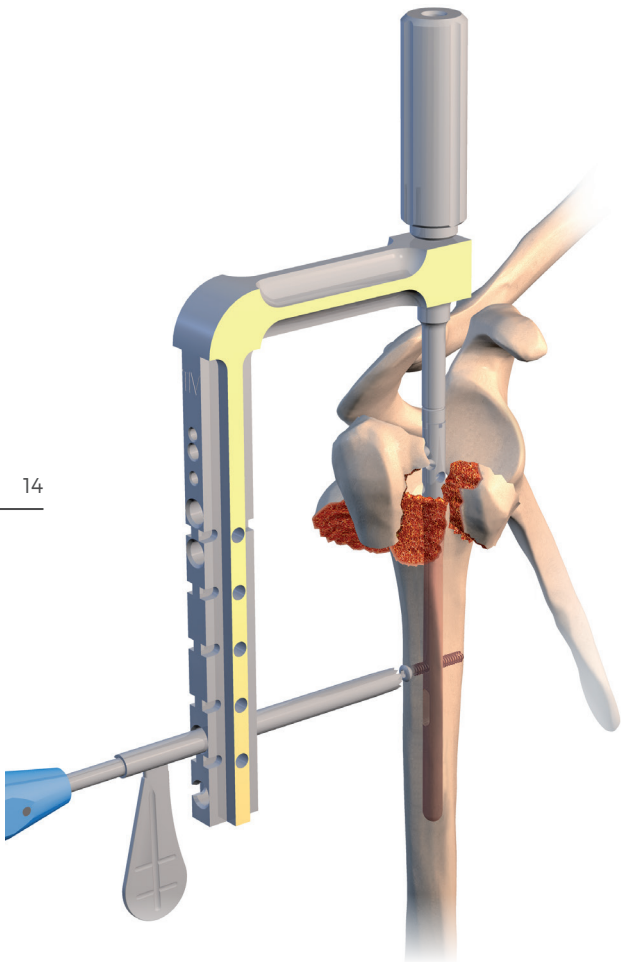

fig. 27

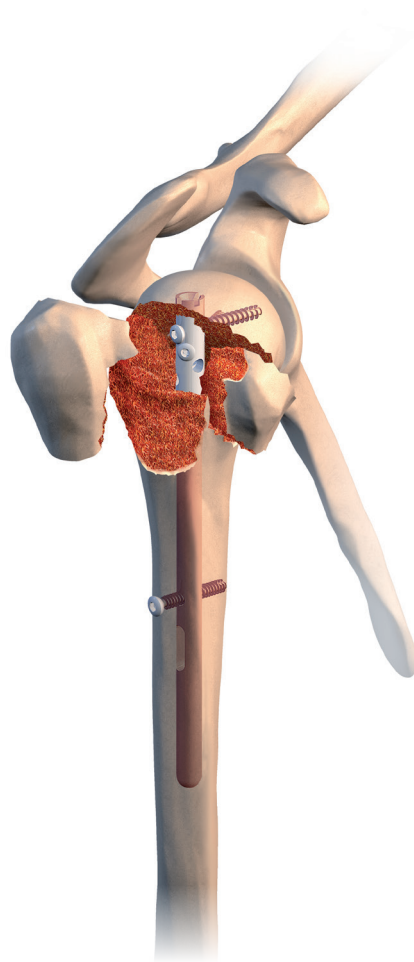

fig. 28

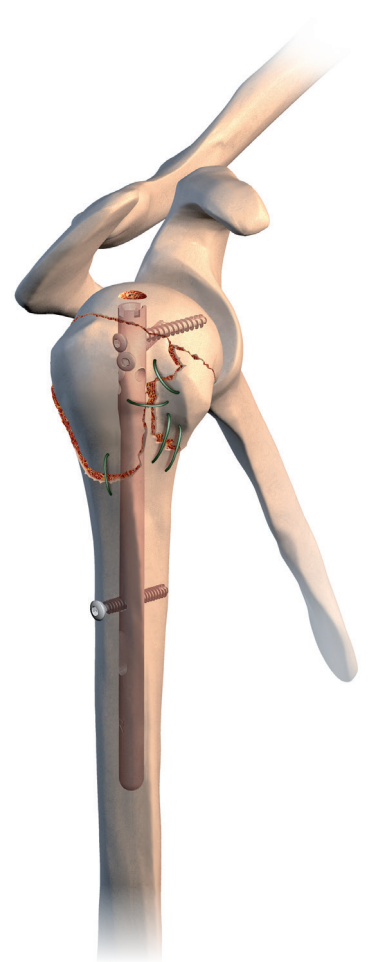
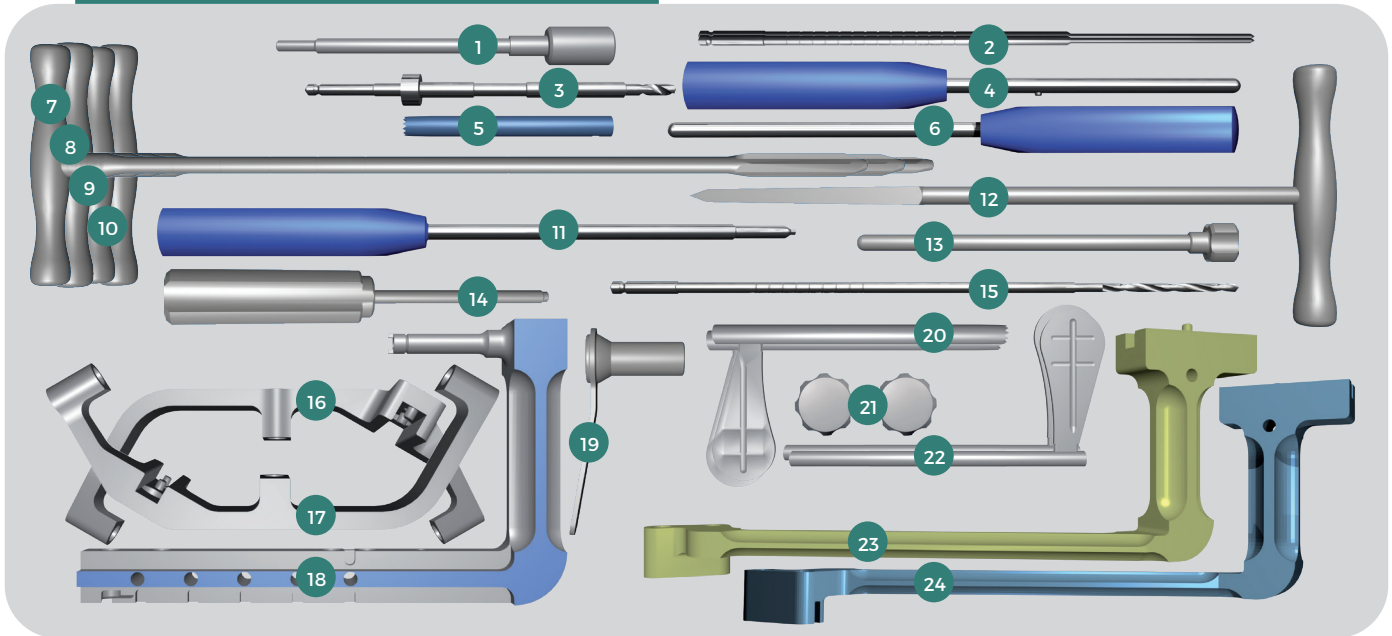

fig. 29

# 7. INSTRUMENTATION

ref. 270 803  
Telegraph Evolution® case V1  
ref. 270 805  
Telegraph Evolution® lid  
ref. 264 579  
Telegraph IV case V1  
(can replace case 270 803 + lid 270 805)



- |   |  |
|---|--|
| 1. Telegraph intermediary positioner .....ref. 253 675                        | 13. Telegraph Evolution® drill sleeve for Ø3.1 drill bit .....ref. 270 822 |
| 2. Drill bit Ø2.5 L60 AO .....ref. 250 855                                    | 14. Telegraph Evolution® cannulated connecting screw .....ref. 270 812     |
| 3. Drill bit with stop Ø4.5 AO connector .....ref. 266 428                    | 15. Telegraph Evolution® drill bit Ø3.1 AO connector .....ref. 270 821     |
| 4. Telegraph intermediary obturator with tab .....ref. 253 676                | 16. Telegraph IV left proximal guide .....ref. 264 202                     |
| 5. Telegraph IV short guide sleeve .....ref. 257 010                          | 17. Telegraph IV right proximal guide .....ref. 264 203                    |
| or Short guide sleeve (can replace ref 257 010) .....ref. 253 679             | 18. Telegraph IV nailing arm .....ref. 264 201                             |
| 6. Obturator .....ref. 236 844  | 19. Telegraph Evolution® protection sleeve Ø11 .....ref. 270 807           |
| 7. Telegraph Evolution® rigid cannulated reamer Ø7 .....ref. 270 808          | 20. Guide sleeve for tap .....ref. 253 678                                 |
| 8. Telegraph Evolution® rigid cannulated reamer Ø8 .....ref. 270 809          | 21. Telegraph M5 screw .....ref. 253 681                                   |
| 9. Telegraph Evolution® rigid cannulated reamer Ø9 .....ref. 270 810          | 22. Drill sleeve for Ø2.5 drill bit .....ref. 253 677                      |
| 10. Telegraph Evolution® rigid cannulated reamer Ø10 (option) ...ref. 270 811 | 23. Telegraph right distal guide .....ref. 253 674                         |
| 11. Telegraph 2.5 screwdriver .....ref. 233 339                               | 24. Telegraph left distal guide .....ref. 253 673                          |
| 12. Telegraph Evolution® cannulated trocar-tip awl .....ref. 270 806          |  |

ref. 271 326  
Non-sterile pin Ø2.5 LG 750 (x2)

Take note the instrument set is delivered with 2 non-sterile pins (above).



**The pin must be exchanged after each intervention.**



**DISTRIBUTEURS  
DISTRIBUTORS**

**FR, FH ORTHO SAS**  
3 rue de la Forêt - Zone Industrielle  
BP 50009  
68990 Heimsbrunn CEDEX - FRANCE  
Tél. +33 (0)3 89 81 90 92  
Fax : +33 (0)3 89 81 80 11  
info@fhortho.com  
www.fhortho.com

**USA, FH ORTHOPEDICS INC.**  
OrthoEx  
7327 E Tierra Buena Lane  
Scottsdale, Arizona 85260 - USA  
Phone: +1 (412) 965-0950  
customerservice@fhortho-us.com  
www.fhortho.com

**PL, FH ORTHO POLSKA**  
Ul. Garbary 95/A6,  
61-757 Poznan - POLSKA  
Phone: +48 61 863 81 27  
Fax: +48 61 863 81 28  
biuro@implants24.pl  
www.fhortho.com



**FABRICANT  
MANUFACTURER**

**FR, FH INDUSTRIE**  
6 rue Nobel, Z.I. de Kernevez  
29000 QUIIMPER - FRANCE  
Tél. +33 (0)2 98 55 68 95  
Fax : +33 (0)2 98 53 42 13  
contact-fhi@fhortho.com  
www.fhortho.com